

COLLECTION 2020-2024

nelux hong kong international, ltd



**COMMERCIAL & RESIDENTIAL
OUTDOOR LIGHTING**



ARCHITECTURAL LIGHTING

MINI LED DOWNLIGHTS

hotel
shops
home
office
cafe....

Our MINI SPOTLIGHT are made from Aluminium Die-casting, electrostatic powder coating, and aluminum Reflectors made from Aluminium anodized specular silver.

Brand of Chip CREE and other brands like Citizen and Bridgelux available, Led Driver Khün, Xz, Osram, Philips.

Input Voltage Multivoltage and 220-240VAC/50-60Hz



MS4035 3W



MS5035 3W



MS5828 3W



MS820 3W



MS022 3W



MS020 3W



MS5818S 3W



MS5042R 3W



MS5042S 3W



MS60100 1W



MS80100 2*1W



MS9090 2W



MS5054 3W



Model Mini Spotlight
Series Petite reference
MS5820 3W ~190lm
black color



MS4035

Input Voltage AC220-240V, Multivoltage
 Light Power 3W
 Luminous flux ~190lm
 Light Source CREE cob led
 CCT 2700K, 3000K, 4000K
 CRI 80 as standard, CRI>90 as an option
 Beam Angle lens 10°, 20°, 40°
 Driver, Khun, Xz, Philips other options available

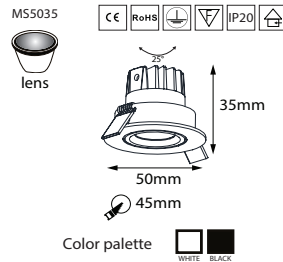

MS5035

Input Voltage AC220-240V, Multivoltage
 Light Power 3W
 Luminous flux ~190lm
 Light Source CREE cob led
 CCT 2700K, 3000K, 4000K
 CRI 80 as standard, CRI>90,95,97 as an option
 Beam Angle lens 10°, 20°, 40°
 Driver, Khun, Xz, Philips other options available



MS5828

Input Voltage AC220-240V, Multivoltage
 Light Power 3W
 Luminous flux ~190lm
 Light Source CREE cob led
 CCT 2700K, 3000K, 4000K
 CRI 80 as standard, CRI>90,95,97 as an option
 Beam Angle lens 24°, 38°
 Driver, Khun, Xz, Philips other options available

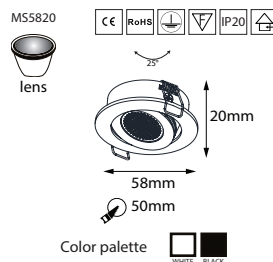
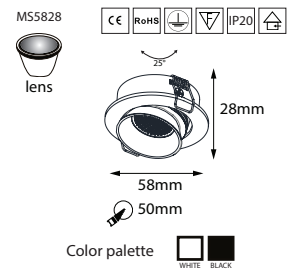

MS5820

Input Voltage AC220-240V, Multivoltage
 Light Power 3W
 Luminous flux ~190lm
 Light Source CREE cob led
 CCT 2700K, 3000K, 4000K
 CRI 80 as standard, CRI>90,95,97 as an option
 Beam Angle lens 24°, 38°
 Driver, Khun, Xz, Philips other options available



MS5022

Input Voltage AC220-240V, Multivoltage
 Light Power 3W
 Luminous flux ~190lm
 Light Source CREE cob led
 CCT 2700K, 3000K, 4000K
 CRI 80 as standard, CRI>90,95,97 as an option
 Beam Angle lens 24°, 38°
 Driver, Khun, Xz, Philips other options available

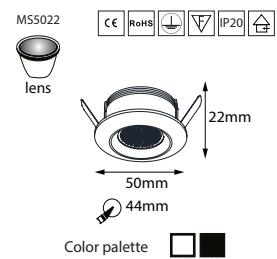

MINI SPOTLIGHT

nelux architectural lighting



MS5020

Input Voltage AC220-240V, Multivoltage
 Light Power 3W
 Luminous flux ~190lm
 Light Source CREE cob led
 CCT 2700K, 3000K, 4000K
 CRI 80 as standard, CRI>90,95,97 as an option
 Beam Angle lens 24°, 38°
 Driver, Khun, Xz, Philips other options available

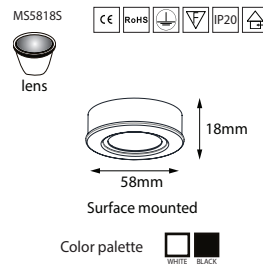

MS58185

Input Voltage AC220-240V, Multivoltage
 Light Power 3W
 Luminous flux ~190lm
 Light Source CREE cob led
 CCT 2700K, 3000K, 4000K
 CRI 80 as standard, CRI>90,95,97 as an option
 Beam Angle lens 15°, 24°
 Driver, Khun, Xz, Philips other options available



MS5042 Round

Input Voltage AC220-240V, Multivoltage
 Light Power 3W
 Luminous flux ~190lm
 Light Source CREE cob led
 CCT 2700K, 3000K, 4000K
 CRI 80 as standard, CRI>90,95,97 as an option
 Beam Angle lens 25°
 Driver, Khun, Xz, Philips other options available

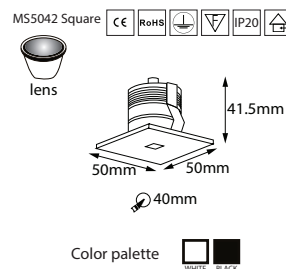
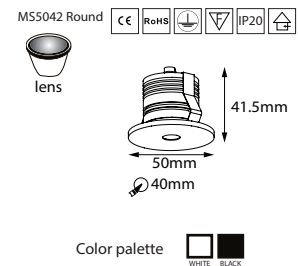

MS5042 Square

Input Voltage AC220-240V, Multivoltage
 Light Power 3W
 Luminous flux ~190lm
 Light Source CREE cob led
 CCT 2700K, 3000K, 4000K
 CRI 80 as standard, CRI>90,95,97 as an option
 Beam Angle lens 25°
 Driver, Khun, Xz, Philips other options available

PETITE SERIES



MS60100

Input Voltage AC220-240V, Multivoltage
 Light Power 1*1W
 Luminous flux ~80lm
 Light Source CREE cob led
 CCT 2700K, 3000K, 4000K
 CRI 80 as standard, CRI>90,95,97 as an option
 Beam Angle lens 20°
 Driver, Khun, Xz, Philips other options available

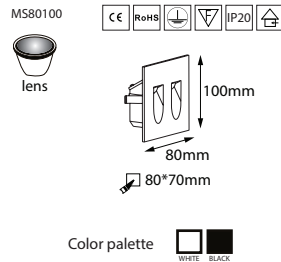
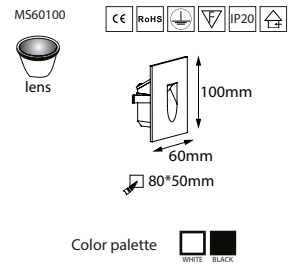

MS80100

Input Voltage AC220-240V, Multivoltage
 Light Power 2*1W
 Luminous flux ~160lm
 Light Source CREE cob led
 CCT 2700K, 3000K, 4000K
 CRI 80 as standard, CRI>90,95,97 as an option
 Beam Angle lens 20°
 Driver, Khun, Xz, Philips other options available



MS9090

Input Voltage AC220-240V, Multivoltage
 Light Power 2W
 Luminous flux ~160lm
 Light Source CREE cob led
 CCT 2700K, 3000K, 4000K
 CRI 80 as standard, CRI>90,95,97 as an option
 Beam Angle 36°
 Driver, Khun, Xz, Philips other options available

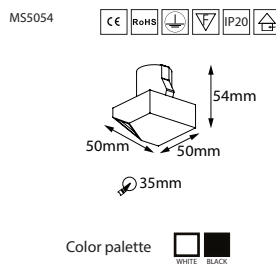
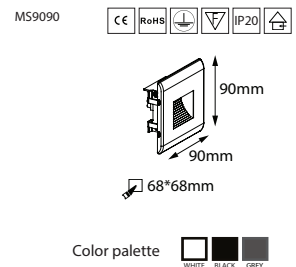

MS5054

Input Voltage AC220-240V, Multivoltage
 Light Power 3W
 Luminous flux ~190lm
 Light Source CREE cob led
 CCT 2700K, 3000K, 4000K
 CRI 80 as standard, CRI>90,95,97 as an option
 Beam Angle lens 20°
 Driver, Khun, Xz, Philips other options available

PETITE SERIES



We suggest you to use a modern, energy-efficient LED lighting technology like Mini Combi and Combi models can be easily integrated into your projects and provide the necessary light therefore creating a pleasant atmosphere. Different frames and different power available in these series.

MINI COMBI 3

MINI COMBI and COMBI light

nelux architectural lighting

MINI COMBI 3W



Application to Hotels

Light Engine



+

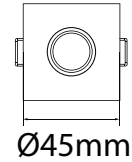
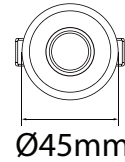
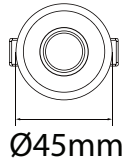
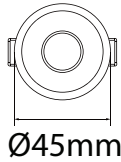

||

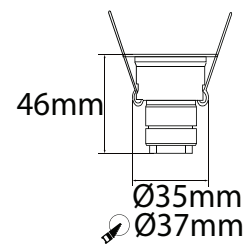
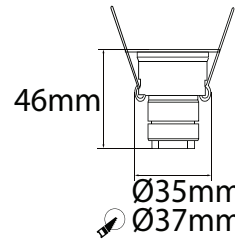
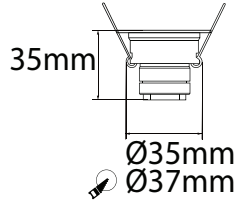
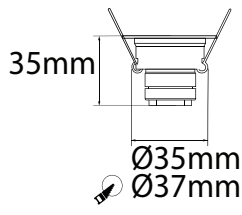
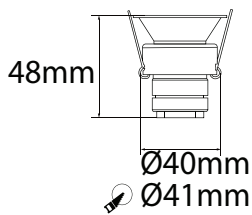

3 Years Warranty

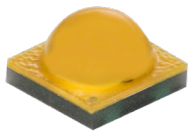
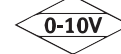

CREE XT-E white

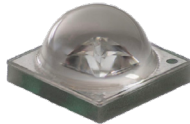

CREE XT-E blue royal



With **MINI COMBI** products architectural features, artwork, textures, foliage, corridors, rooms or other features are subtly highlighted, in a sympathetic and tasteful way bringing key elements to life and add interest and energy to a space.

Applications

Hotels, apartments, private villa, museums, private residences, restaurants, cafe, ...

MINI COMBI 3

MINI COMBI and COMBI light

nelux architectural lighting

MINI COMBI 3W

Main Features

Housing made from pure aluminum
 Input Voltage 220-240VAC, Multi-voltage 110-260VAC 50/60Hz
 Output Wattage 3W
 Led Luminous Flux 210lm
 Led Source CREE XPE led
 CCT 2700K, 3000K, 5000K
 Beam Angle 10°, 15°, 25°, 30°, 45°, 60°

STANDARD

LED DRIVER
 (1-3)*1W
 Input AC100-260V 50/60Hz
 Output DC3V 700mA+5%

Optional

Dimming Led Driver

0-10V Driver 10W for 4 Mini Combi 100-265V Output V 10-15V 700mA PF>0.9
 0-10V Driver 20W for 7 Mini Combi 100-265V Output V 15-25V 700mA PF>0.9

Trailing edge driver

Trailing edge 6-12W mini combi 2-4pcs
 Trailing edge 15-18W mini combi 5-6pcs

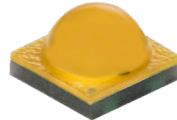

CREE XT-E XP-E white

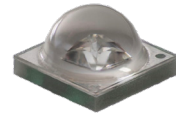

CREE XT-E XP-E blue royal

Clear surface lens 10°

Clear beads lens 10°, 15°, 25°, 30°, 45°, 60°



MINI COMBI APPLICATION

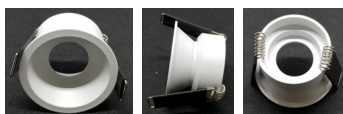
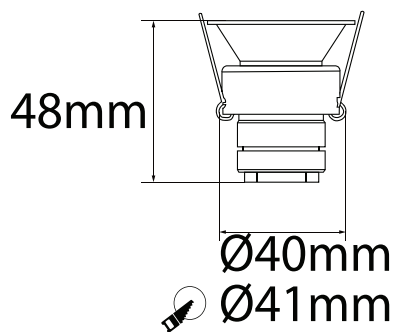

www.nelux.com.hk

lighting product designers and mold management

COMBI 8



Application to Hotels

Light Engine



+

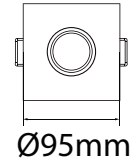
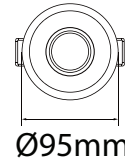
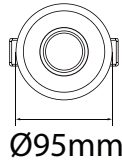
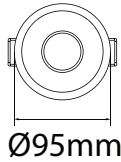

||

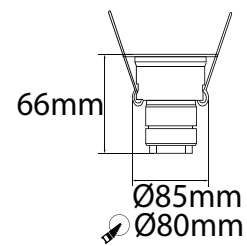
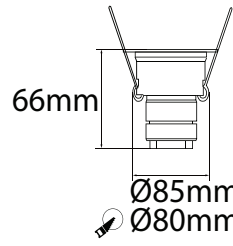
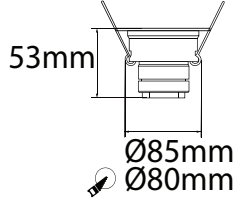
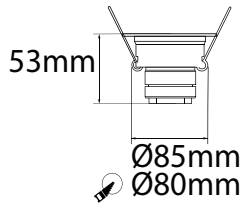
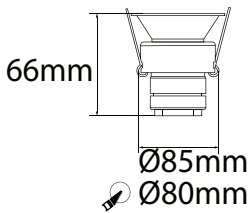

3 Years Warranty

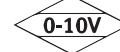

With **COMBI 8** products architectural features, artwork, textures, foliage, corridors, rooms or other features are subtly highlighted, in a sympathetic and tasteful way bringing key elements to life and add interest and energy to a space.

Applications

Hotels, apartments, private villa, museums, private residences, restaurants, cafe, ...

COMBI 8

MINI COMBI and COMBI light

nelux architectural lighting

COMBI 8

Main Features

Housing made from pure aluminum
 Input Voltage 220-240VAC, Multi-voltage 110-260VAC 50/60Hz
 Output Wattage ~7W
 Led Luminous Flux 560lm
 Led Source CREE led
 CCT 2700K, 3000K, 5000K
 Beam Angle 30°, 45°, 60°

STANDARD

LED DRIVER
 1*8W
 Input AC100-260V 50/60Hz
 Output DC36V 200mA+5%

Optional

Dimming Led Driver
 Trailing edge driver

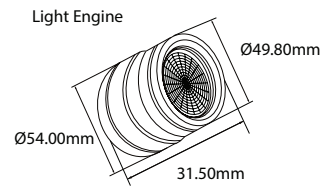
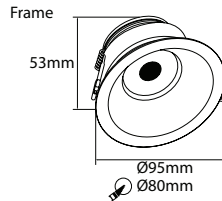

COMBI APPLICATION

Clear surface lens 30°, 45°, 60°

Clear beads lens 30°, 45°, 60°

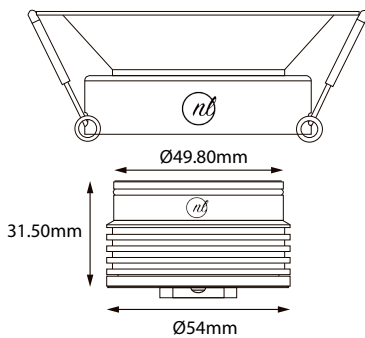

COMBI 8

